



The most powerful and stylish navigation to date.

# *de antonio* YACHTS

De Antonio Yachts was born from the passion for the sea and design of its founders, from the interest to innovate and build boats with simple and vanguard lines, that provide new solutions and concepts that improve efficiency, usability and performance. A brand aimed for demanding boat owners looking for something new and different that exceeds their expectations. Boats powered by innovation, to live the sea with style, sportiness and comfort.

*De Antonio Yachts nació de la pasión de sus fundadores por el mar y el diseño, con el interés de innovar creando barcos de líneas simples y vanguardistas que ofrezcan nuevas soluciones y conceptos que mejoren la eficiencia, la facilidad de uso y las prestaciones. Una marca dirigida a propietarios de embarcaciones exigentes que buscan algo nuevo y diferente que supere sus expectativas. Barcos impulsados por la innovación, para vivir el mar con estilo, deportividad y comodidad.*



# E23

The E23 is the brand's first 100% electric boat, the beginning of a new era.

An innovative model, which bases its concept on maximum efficiency. Its compact proportions with catamaran architecture integrating a "foil" between its hulls, give it unique emission-free sailing performance in its segment while offering a practical and comfortable space on deck with a careful design in many details and finishes.

A model that combines cutting-edge technology and design. The new E23 has been chosen, by the organization of the most important sailing competition in the world, to be the Official Electric Boat of the 37th Edition of the America's Cup to be held in Barcelona in 2024.

*El E23 es el primer barco 100% eléctrico de la marca, el inicio de una nueva era.*

*Un modelo innovador, que basa su concepto en la máxima eficiencia. Sus compactas proporciones con arquitectura de catamarán integrando un "foil" entre sus cascos, lo dotan de unas prestaciones de navegación sin emisiones únicas en su segmento al mismo tiempo que ofrece un práctico y confortable espacio en cubierta con un cuidado diseño en numerosos detalles y acabados.*

*Un modelo que aúna tecnología y diseño de vanguardia. El nuevo E23 ha sido el elegido por la organización de la competición a vela más importante de mundo para ser el Barco Eléctrico Oficial de la 37th Edición de la America's Cup que se celebrará en Barcelona en 2024.*



OFFICIAL ELECTRIC BOAT OF 37 TH AMERICA'S CUP





OFFICIAL ELECTRIC BOAT OF 37 TH AMERICA'S CUP



## TECHNICAL SPECIFICATIONS / ESPECIFICACIONES TÉCNICAS

OVERALL LENGTH / <i>ESLORA TOTAL</i>	7,20 m	ELECTRIC OUTBOARD ENGINE / <i>MOTOR ELÉCTRICO FUERABORDA</i>	1 uds.
WATERLINE LENGTH / <i>ESLORA TOTAL CON PLATAFORMA XL OPCIONAL</i>	6,40 m	MAXIMUM POWER	50 kW / 68 hp
BEAM / <i>MANGA</i>	2,30 m	MINIMUM POWER	20 kW / 27 hp
DRAFT / <i>CALADO</i>	0,40 m	BATTERY CAPACITY / <i>DEPÓSITO DE COMBUSTIBLE</i>	40 kWh
PASSENGERS / <i>OCUPANTES</i>	8 pax	DISPLACEMENT / <i>DESPLAZAMIENTO</i>	1.600 Kg



### HIDDEN ELECTRIC OUTBOARD ENGINE

MOTOR ELÉCTRICO FUERABORDA OCLUTO

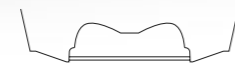

### INTEGRATED FOIL

FOIL INTEGRADO

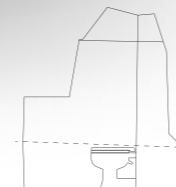

### STORAGE CABIN \*WC OPTIONAL

CABINA DE ALMACENAJE \*INODORO OPCIONAL

## MOTORIZATION / MOTORIZACIÓN

### TORQUEEDO OUTBOARD ENGINES / TORQUEEDO FUERABORDA ELÉCTRICO

1 X 50 KW OUTBOARD DEEP BLUE 50RXL

### E'DYN OUTBOARD ENGINES / E'DYN FUERABORDA ELÉCTRICO

1 X 20 KW OUTBOARD MARINE 20

## STANDARD EQUIPMENT / EQUIPAMIENTO DE SERIE

CASTED ALLOY FOIL SYSTEM	SISTEMA FOIL EN FUNDICIÓN DE ALUMINIO
WHITE COLOUR HULL RAL 9016	CASCO COLOR BLANCO RAL 9016
NON-SKID DECK FINISH	CUBIERTA CON ACABADO ANTIDESLIZANTE
CUSHION & UPHOLSTERY PREMIUM MORBERN SUNDANCE® HERM	COJINES Y TAPICERÍA PREMIUM MORBERN SUNDANCE® HERM
PILOT BENCH SEATS IN MORBERN ALLANTE® GREY UPHOLSTERY SWIMMING LADDER	ASIENTOS BANCO PILOTO EN TAPICERÍA MORBERN ALLANTE® GREY
FOLDING BACKREST	RESPALDO PLEGABLE ASIENTOS PILOTO
SWIMMING LADDER	ESCALERA DE BAÑO
HORN	BOCINA
COMPOSITE FLAGPOLE	ASTA DE BANDERA
RETRACTABLE CLEATS IN STAINLESS STEEL	CORNAMUSAS RETRÁCTILES DE ACERO INOXIDABLE
GRAPNEL ANCHOR + 7M CHAIN + 28M ROPE	ANCLA DE REZÓN CON 7M DE CADENA Y 28M DE CABO
AC SHORE POWER AND CABLE / BATTERY CHARGER	TOMA DE TIERRA Y CABLE / CARGADOR DE BATERÍA
AUDIO SYSTEM FUSION RA60 (2 SPEAKERS)	SISTEMA DE AUDIO FUSION SERIE RA-60 (2 ALTAVOCES)
NAVIGATION SYSTEM SCREEN (9")	SISTEMA DE NAVEGACIÓN SIMRAD (9")
LED NAVIGATION LIGHTS	LUCES DE NAVEGACIÓN LED
OUTLET 12V	ENCHUFE 12V
INTERIOR FUSE PANEL	PANEL INTERIOR DE FUSIBLES
BILGE PUMPS	BOMBAS DE ACHIQUE
70 AH SERVICE BATTERY	BATERÍA DE SERVICIO DE 70 AH
INTERIOR STORAGE AREA (1,2 X 0,8 X 1,2 METERS)	ESPACIO DE ALMACENAMIENTO INTERIOR (1,2 X 0,8 X 1,2 M)
TWO AFT EXTERIOR AREA STORAGE BOXES	DOS ESPACIOS DE ALMACENAMIENTO EXTERIOR
THREE BOW EXTERIOR STORAGE SPACES	TRES ESPACIOS DE ALMACENAMIENTO EXTERIOR EN PROA



\*CABIN WC OPT. \*INODORO EN CABINA OPC.



# D28

O P E N

The D28 Open is the pioneer of the length, following the philosophy of its successful predecessors, gathering their best features. This developed V shape hull motorboat slides through the waves and allows a quick and smooth gliding, achieving top performance as well as enjoyable navigation at cruising speed. Designed to satisfy all sea lovers looking for a stylish boat with a mix of sport and comfort with an incomparable sensation of spaciousness. Nominated for European Power Boat of the Year 2018, the D28 Open will take your boat experiences to the next level.

*El D28 Open es el pionero en su eslora, siguiendo la filosofía de sus exitosos predecesores y reuniendo sus mejores características. Su evolucionado casco en V le permite planear sobre las olas de forma rápida y suave, logrando un rendimiento excelente y una navegación confortable a velocidad de crucero. Diseñado para satisfacer a los amantes del mar más exigentes que buscan un barco con estilo y una combinación de deportividad y confort con una amplitud en cubierta incomparable. Nominado a Barco Europeo del Año 2018, el D28 Open llevará sus experiencias náuticas a otro nivel.*

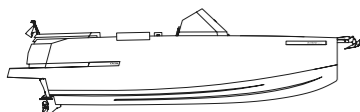



## TECHNICAL SPECIFICATIONS / ESPECIFICACIONES TÉCNICAS

LENGTH OVERALL / <i>ESLORA TOTAL</i>	7,99 m	MAXIMUM POWER / <i>POTENCIA MÁXIMA</i>	400 HP
LENGTH OVERALL WITH PLATFORM XL OPTION / <i>ESLORA TOTAL CON PLATAFORMA XL OPCIONAL</i>	8,49 m	FUEL TANK / <i>DEPÓSITO DE COMBUSTIBLE</i>	440 L
BEAM / <i>MANGA</i>	2,99 m	WATER TANK / <i>DEPÓSITO DE AGUA DULCE</i>	88 L
DEPTH / <i>CALADO</i>	0,50 m	DISPLACEMENT / <i>DESPLAZAMIENTO</i>	2.500 Kg
PASSENGERS / <i>OCUPANTES</i>	10 pax		
OUTBOARD ENGINES / <i>MOTORES FUERABORDA</i>	2 uds.		



**HIDDEN OUTBOARD ENGINES**  
MOTORES FUERABORDA OCULTOS

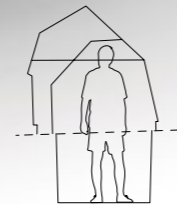

**COMPLETE BATHROOM**  
BAÑO COMPLETO

## MOTORIZATION / MOTORIZACIÓN

2 X 200 HP MERCURY V-6 FOURSTROKE® (4 STROKE) OUTBOARD / (4 TIEMPOS) FUERABORDA  
ACTIVE TRIM MERCURY MARINE®

## STANDARD EQUIPMENT / EQUIPAMIENTO DE SERIE

WHITE COLOR HULL	CASCO COLOR BLANCO
ARTIFICIAL TEAK DECK FLEXITEEK® SCRUBBED WITH BLACK LINES	CUBIERTA DE TECA SINTÉTICA FLEXITEEK® SCRUBBED Y LÍNEAS NEGRAS
ANCHOR SUPPORT, ANCHOR, CHAIN AND ELECTRIC WINCH	SOPORTE DE ANCLA, ANCLA, CADENA Y MOLINETE ELÉCTRICO
LED NAVIGATION LIGHTS	LUCES DE NAVEGACIÓN LED
TABLE ON STERN	MESA FIJA EN POPA
RETRACTABLE TABLE ON BOW	MESA RETRÁCTIL EN PROA
SWIMMING LADDER	ESCALERA DE BAÑO
HANDHOLDS WITH FABRIC FINISHES	ASIDEROS CON ACABADOS EN TELA
FLAGPOLE	ASTA DE BANDERA
USB PLUG 12 V OUTLET	ENCHUFE USB 12V
CUSHIONS AND UPHOLSTERY MORBERN SUNDANCE® HERM	COJINES Y TAPICERÍA MORBERN SUNDANCE® HERM
SET OF TWO FENDERS (SPECIAL D28 MODEL)	JUEGO DE DOS DEFENSAS (MODELO ESPECIAL D28)
RETRACTABLE CLEATS IN ALUMINIUM	CORNAMUSAS RETRÁCTILES DE ALUMINIO
CARBON TRIMS ON BOWS AND SIDES	EMBELLECEDORES DE CARBONO EN LAS AMURAS Y COSTADOS
NAVIGATION SYSTEM SIMRAD (7")	SISTEMA DE NAVEGACIÓN SIMRAD (7")
AUDIO SYSTEM FUSION RA55 (4 SPEAKERS)	SISTEMA DE AUDIO FUSION RA55 (4 ALTAVOCES)
BILGE PUMPS	BOMBAS DE ACHIQUE
SHOWER ON DECK	DUCHA AGUA DULCE EN CUBIERTA
COMPLETE BATHROOM (ELECTRIC WC)	BAÑO COMPLETO (WC ELÉCTRICO)





# D28

X P L O R E R

Aimed for sea enthusiasts, the D28 Xplorer merges unprecedented habitability in its walk-around deck with different seating areas and solariums, offering safety and protection on board thanks to its semi-cabined structure. Its refined water lines and hidden outboard engines provide excellent navigation features that, with the combination of sporty lines and numerous design details, give a unique style and great personality. A boat created to enjoy the best adventures and explore the sea like never before.

*Dirigido a entusiastas del mar, el D28 Xplorer combina una habitabilidad sin precedentes en su cubierta tipo walk-around con distintas zonas de asientos y solariums, ofreciendo seguridad y protección a bordo gracias a su estructura semi-cabinada. Sus depuradas líneas de agua y la motorización de fuerabordas ocultos proporcionan unas prestaciones de navegación excelentes que, junto a la combinación de líneas deportivas y numerosos detalles de diseño, le confieren un estilo único y con gran personalidad. Un barco creado para disfrutar de las mejores aventuras y explorar el mar como nunca.*

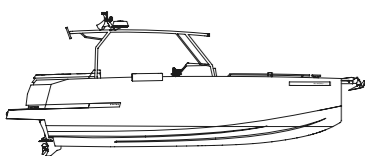



## TECHNICAL SPECIFICATIONS / ESPECIFICACIONES TÉCNICAS

LENGTH OVERALL / <i>ESLORA TOTAL</i>	7,99 m	OUTBOARD ENGINES / <i>MOTORES FUERABORDA</i>	2 uds.
LENGTH OVERALL WITH PLATFORM OPTION / <i>ESLORA TOTAL CON PLATAFORMA OPCIONAL</i>	8,49 m	POWER / <i>POTENCIA</i>	400 HP
BEAM / <i>MANGA</i>	2,99 m	FUEL TANK / <i>DEPÓSITO DE COMBUSTIBLE</i>	440 L
DEPTH / <i>CALADO</i>	0,50 m	WATER TANK / <i>DEPÓSITO DE AGUA DULCE</i>	88 L
PASSENGERS / <i>OCUPANTES</i>	10 pax	DISPLACEMENT / <i>DESPLAZAMIENTO</i>	2.600 Kg



### HIDDEN OUTBOARD ENGINES

MOTORES FUERABORDA OCULTOS

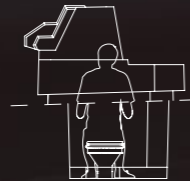

### STORAGE CABIN TOILET

CABINA DE ALMACENAJE / INODORO

## MOTORIZATION / MOTORIZACIÓN

2 X 200 HP MERCURY V-6 FOURSTROKE® (4 STROKE) OUTBOARD / (4 TIEMPOS) FUERABORDA  
ACTIVE TRIM MERCURY MARINE®

## STANDARD EQUIPMENT / EQUIPAMIENTO DE SERIE

WHITE COLOR HULL	CASCO COLOR BLANCO
TUBULAR STRUCTURE WITH RIGID ROOF AND SLIDING HATCH	ESTRUCTURA TUBULAR CON TECHO RÍGIDO Y ESCOTILLA CORREDIZA
ARTIFICIAL TEAK DECK FLEXITEEK® SCRUBBED WITH BLACK LINES	CUBIERTA DE TECA SINTÉTICA FLEXITEEK® SCRUBBED Y LÍNEAS NEGRAS
ANCHOR SUPPORT, ANCHOR, CHAIN AND ELECTRIC WINCH	SOPORTE DE ANCLA, ANCLA, CADENA Y MOLINETE ELÉCTRICO
LED NAVIGATION LIGHTS	LUCES DE NAVEGACIÓN LED
SWIMMING LADDER	ESCALERA DE BAÑO
FLAGPOLE	ASTA DE BANDERA
USB PLUG 12 V OUTLET	ENCHUFE USB 12V
CLEATS	CORNAMUSAS
CUSHIONS AND UPHOLSTERY MORBERN SUNDANCE® HERM	COJINES Y TAPICERÍA MORBERN SUNDANCE® HERM
CARBON TRIMS ON BOWS AND SIDES	EMBELLECEDORES DE CARBONO EN LAS AMURAS Y COSTADOS
NAVIGATION SYSTEM SIMRAD (7")	SISTEMA DE NAVEGACIÓN SIMRAD (7")
AUDIO SYSTEM FUSION RA55 (4 SPEAKERS)	SISTEMA DE AUDIO FUSION RA55 (4 ALTAVOCES)
BILGE PUMPS	BOMBAS DE ACHIQUE
SHOWER ON DECK	DUCHA AGUA DULCE EN CUBIERTA
MANUAL WC	WC MANUAL
THREE BUCKET SEATS	TRES ASIENTOS BUCKET



# D28

D E C K

The layout design of the D28 Deck takes to the extreme the "day boat" concept to create a diaphanous deck with large areas of solariums, getting a matchless space and feeling of amplitude on board. Its innovative configuration and the avant-garde design gives it a unique style while making it an incredibly practical and easy to maneuver the boat. An intelligent solution for living great days at sea with the best company.

*El diseño de la cubierta del D28 Deck lleva al extremo el concepto "day boat" para crear una cubierta diáfana con grandes zonas de solárium, consiguiendo un espacio y sensación de amplitud a bordo inigualable. Su innovadora configuración y su diseño vanguardista le confieren un estilo único al mismo tiempo que lo convierten en un barco increíblemente práctico y fácil de maniobrar. Una solución inteligente para vivir grandes días en el mar con la mejor compañía.*

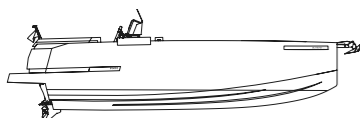



## TECHNICAL SPECIFICATIONS / ESPECIFICACIONES TÉCNICAS

LENGTH OVERALL / <i>ESLORA TOTAL</i>	7,99 m	MAXIMUM POWER / <i>POTENCIA MÁXIMA</i>	400 HP
LENGTH OVERALL WITH PLATFORM XL OPTION / <i>ESLORA TOTAL CON PLATAFORMA XL OPCIONAL</i>	8,49 m	FUEL TANK / <i>DEPÓSITO DE COMBUSTIBLE</i>	440 L
BEAM / <i>MANGA</i>	2,99 m	WATER TANK / <i>DEPÓSITO DE AGUA DULCE</i>	88 L
DEPTH / <i>CALADO</i>	0,50 m	DISPLACEMENT / <i>DESPLAZAMIENTO</i>	2.300 Kg
PASSENGERS / <i>OCUPANTES</i>	10 pax		
OUTBOARD ENGINES / <i>MOTORES FUERABORDA</i>	2 uds.		



### HIDDEN OUTBOARD ENGINES

MOTORES FUERABORDA OCULTOS



### RECLINING BACK

ESPALDAR RECLINABLE

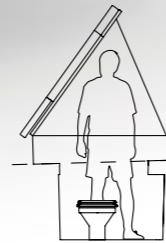

### STORAGE CABIN TOILET

CABINA DE ALMACENAJE / INODORO

## MOTORIZATION / MOTORIZACIÓN

2 X 200 HP MERCURY V-6 FOURSTROKE® (4 STROKE) OUTBOARD / (4 TIEMPOS) FUERABORDA  
ACTIVE TRIM MERCURY MARINE®

## STANDARD EQUIPMENT / EQUIPAMIENTO DE SERIE

WHITE COLOR HULL	CASCO COLOR BLANCO
ARTIFICIAL TEAK DECK FLEXITEEK SCRUBBED WITH BLACK LINES®	CUBIERTA DE TECA SINTÉTICA FLEXITEEK® SCRUBBED Y LÍNEAS NEGRAS
ANCHOR SUPPORT, ANCHOR, CHAIN AND ELECTRIC WINCH	SOPORTE DE ANCLA, ANCLA, CADENA Y MOLINETE ELÉCTRICO
LED NAVIGATION LIGHTS	LUCES DE NAVEGACIÓN LED
RETRACTABLE TABLE ON BOW	MESA RETRÁCTIL EN PROA
SWIMMING LADDER	ESCALERA DE BAÑO
HANDHOLDS WITH FABRIC FINISHES	ASIDEROS CON ACABADOS EN TELA
FLAGPOLE	ASTA DE BANDERA
USB PLUG 12 V OUTLET	ENCHUFE USB 12V
CUSHIONS AND UPHOLSTERY MORBERN SUNDANCE® HERM	COJINES Y TAPICERÍA MORBERN SUNDANCE® HERM
SET OF TWO FENDERS (SPECIAL D28 MODEL)	JUEGO DE DOS DEFENSAS (MODELO ESPECIAL D28)
RETRACTABLE CLEATS IN ALUMINIUM	CORNAMUSAS RETRÁCTILES DE ALUMINIO
CARBON TRIMS ON BOWS AND SIDES	EMBELLECEDORES DE CARBONO EN LAS AMURAS Y COSTADOS
NAVIGATION SYSTEM SIMRAD (7")	SISTEMA DE NAVEGACIÓN SIMRAD (7")
AUDIO SYSTEM FUSION RA55 (2 SPEAKERS)	SISTEMA DE AUDIO FUSION RA55 (+2 ALTAVOCES)
BILGE PUMPS	BOMBAS DE ACHIQUE
SHOWER ON DECK	DUCHA AGUA DULCE EN CUBIERTA



# D28

CRUISER

The D28 Cruiser is the cabined version of its length. A boat with the purest DNA of the brand, which emanates sportsmanship while offering a comfortable and wide deck space, along with a cozy interior cabin. A family boat, which, thanks to its evolving windshield, protects the occupants from the wind without renouncing the walkaround deck with a stern bathing platform. Its motorization with hidden outboard in both mono or twin-engine version gives it unmatched performance with low maintenance. What more could you want? The D28 Cruiser has it all!

*El D28 Cruiser es la versión cabinada de su eslora. Un barco con el más puro ADN de la marca, que emana deportividad al mismo tiempo que ofrece un confortable y amplio espacio en cubierta junto con una acogedora cabina interior. Un barco familiar que, gracias a su parabrisas envolvente, resguarda del viento a los ocupantes sin renunciar a la disposición de cubierta 'walkaround' con plataforma de baño en popa. Su motorización con fuerabordas ocultos tanto en versión mono o bimotor le confiere unas prestaciones sin igual con un bajo mantenimiento. ¿Qué más se puede pedir? ¡El D28 Cruiser lo tiene todo!*

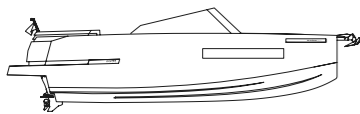





## TECHNICAL SPECIFICATIONS / ESPECIFICACIONES TÉCNICAS

LENGTH OVERALL / <i>ESLORA TOTAL</i>	7,99 m	OUTBOARD ENGINES / <i>MOTORES FUERABORDA</i>	2 uds.
LENGTH OVERALL WITH PLATFORM XL OPTION / <i>ESLORA TOTAL CON PLATAFORMA XL OPCIONAL</i>	8,49 m	POWER / <i>POTENCIA</i>	400 HP
BEAM / <i>MANGA</i>	2,99 m	FUEL TANK / <i>DEPÓSITO DE COMBUSTIBLE</i>	440 L
DEPTH / <i>CALADO</i>	0,50 m	WATER TANK / <i>DEPÓSITO DE AGUA DULCE</i>	88 L
PASSENGERS / <i>OCUPANTES</i>	8 pax	DISPLACEMENT / <i>DESPLAZAMIENTO</i>	2.750 Kg

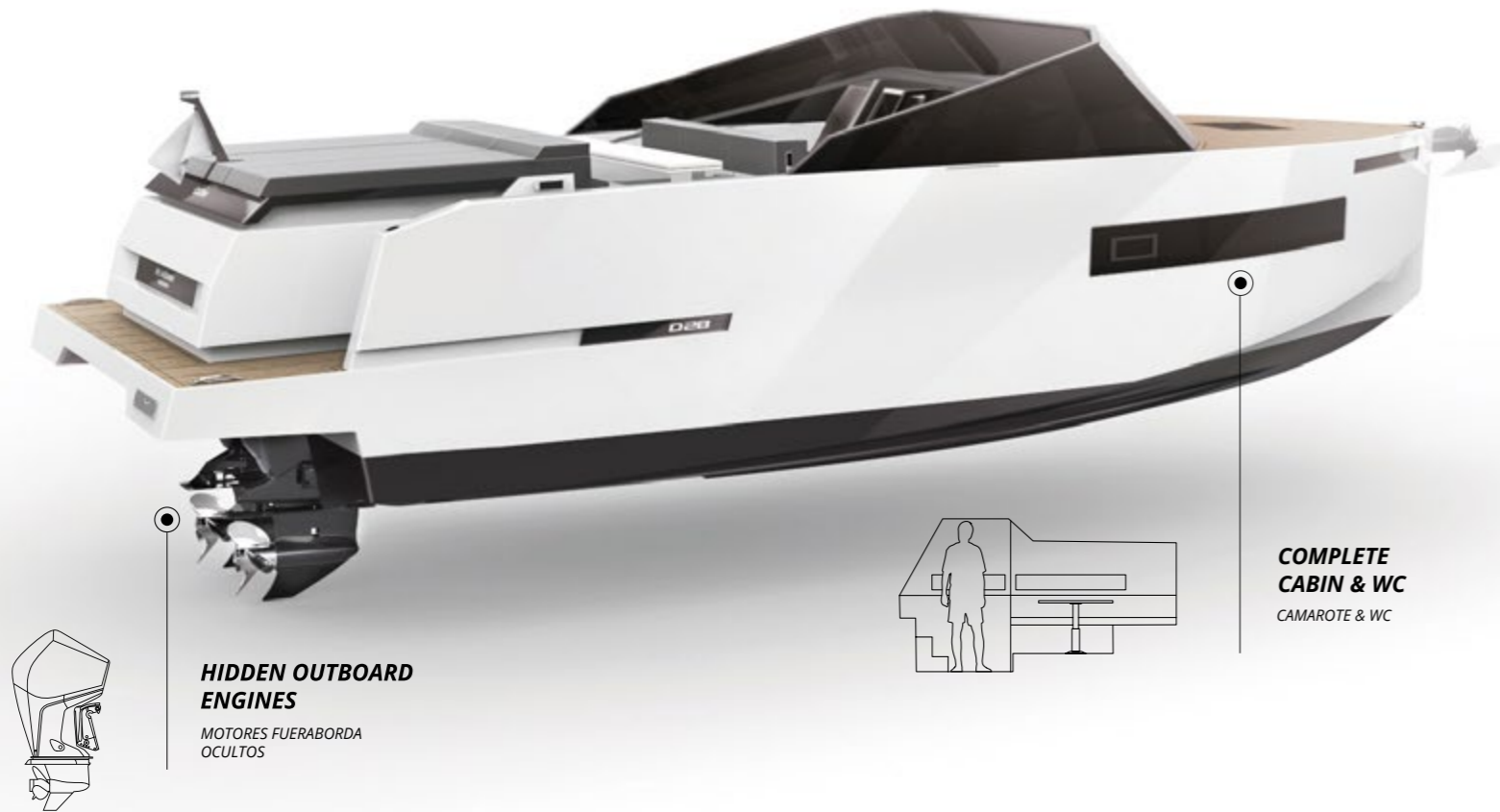

### HIDDEN OUTBOARD ENGINES

MOTORES FUERABORDA OCULTOS

### COMPLETE CABIN & WC

CAMAROTE & WC

## MOTORIZATION / MOTORIZACIÓN

2 X 200 HP MERCURY V-6 FOURSTROKE (4 STROKE) OUTBOARD / (4 TIEMPOS) FUERABORDA  
ACTIVE TRIM MERCURY MARINE®

## STANDARD EQUIPMENT / EQUIPAMIENTO DE SERIE

WHITE COLOR HULL	CASCO COLOR BLANCO
ARTIFICIAL TEAK DECK FLEXITEEK® SCRUBBED WITH BLACK LINES	CUBIERTA DE TECA SINTÉTICA FLEXITEEK® SCRUBBED Y LÍNEAS NEGRAS
ANCHOR SUPPORT, ANCHOR, CHAIN AND ELECTRIC WINCH	SOPORTE DE ANCLA, ANCLA, CADENA Y MOLINETE ELÉCTRICO
LED NAVIGATION LIGHTS	LUCES DE NAVEGACIÓN LED
TABLE ON STERN	MESA FIJA EN POPA
SWIMMING LADDER	ESCALERA DE BAÑO
HANDHOLDS WITH FABRIC FINISHES	ASIDEROS CON ACABADOS EN TELA
FLAGPOLE	ASTA DE BANDERA
USB PLUG 12 V OUTLET	ENCHUFE USB 12V
CUSHIONS AND UPHOLSTERY MORBERN SUNDANCE® HERM	COJINES Y TAPICERÍA MORBERN SUNDANCE® HERM
SET OF TWO FENDERS (SPECIAL D28 MODEL)	JUEGO DE DOS DEFENSAS (MODELO ESPECIAL D28)
RETRACTABLE CLEATS IN ALUMINIUM	CORNAMUSAS RETRACTILES DE ALUMINIO
CARBON TRIMS ON BOWS AND SIDES	EMBELLECEDORES DE CARBONO EN LAS AMURAS Y COSTADOS
NAVIGATION SYSTEM SIMRAD (7")	SISTEMA DE NAVEGACIÓN SIMRAD (7")
AUDIO SYSTEM FUSION RA55 (+2 SPEAKERS)	SISTEMA DE AUDIO FUSION RA55 (+2 ALTAVOCES)
BILGE PUMPS	BOMBAS DE ACHIQUE
SHOWER ON DECK	DUCHA AGUA DULCE EN CUBIERTA
COMPLETE BATHROOM (ELECTRIC WC)	BAÑO COMPLETO (WC ELÉCTRICO)
BOW CABIN WITH TABLE CONVERTIBLE INTO DOUBLE BED	CABINA EN PROA CON MESA CONVERTIBLE EN CAMA DOBLE



# D32

O P E N

The D32 Open, with a length of 10 meters, joins the new generation in design and performance of the brand that began with the award-winning D36 model. Its proportions and exterior lines and its careful definition in every detail, enhance its modern and sporty character that together with the evolved architecture of its high-performance hull give the model a comfortable navigation, with low consumption and high-speed performance.

The “walkaround” deck has a unique distribution of spaces for its length, capable of incorporating, in addition to generous sunbathing areas and benches with central table, a practical outdoor galley. The interior is distributed in an open space with two double berths and a separate bathroom.

The high level of quality and definition of its finishes together with its performance make the D32 Open a compact and sophisticated “day boat” ideal for all audiences.

*El D32 Open con una eslora de 10 metros se suma a la nueva generación en diseño y prestaciones de la marca que se inició con el premiado modelo D36. Sus proporciones y líneas exteriores y su cuidada definición en cada detalle, potencian su carácter moderno y deportivo que junto a la evolucionada arquitectura de su casco de alto rendimiento dotan al modelo una navegación confortable, con bajo consumo y altas prestaciones de velocidad.*

*La cubierta de tipología “walkaround” presenta una distribución de espacios única en su eslora, capaz de incorporar además de generosas zonas de solárium y bancos con mesa central una práctica cocina exterior. El interior se distribuye en un espacio abierto con dos camas dobles y un baño independiente.*

*El alto nivel de calidad y definición de sus acabados junto a sus prestaciones convierten al D32 Open en un “day boat” compacto y sofisticado ideal para todos los públicos.*

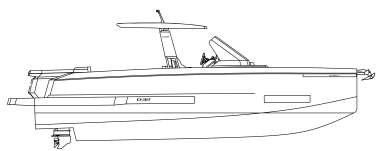



## TECHNICAL SPECIFICATIONS / ESPECIFICACIONES TÉCNICAS

LENGTH OVERALL WITH PLATFORM / <i>ESLORA TOTAL CON PLATAFORMA</i>	9,9 m	MINIMUM POWER / <i>POTENCIA MÍNIMA</i>	400 HP
BEAM / <i>MANGA</i>	3,20 m	MAXIMUM POWER / <i>POTENCIA MÁXIMA</i>	600 HP
DEPTH / <i>CALADO</i>	0,68 m	FUEL TANK / <i>DEPÓSITO DE COMBUSTIBLE</i>	650 L
PASSENGERS / <i>OCUPANTES</i>	10 pax	WATER TANK / <i>DEPÓSITO DE AGUA DULCE</i>	100 L
OUTBOARD ENGINES / <i>MOTORES FUERABORDA</i>	2 uds.	DISPLACEMENT / <i>DESPLAZAMIENTO</i>	3.900 Kg



### HIDDEN OUTBOARD ENGINES

MOTORES FUERABORDA OCULTOS

## MOTORIZATION / MOTORIZACIÓN

2 X 200 HP MERCURY V-6 FOURSTROKE	(4 STROKE) OUTBOARD / (4 TIEMPOS) FUERABORDA
2 X 225 HP MERCURY V-6 FOURSTROKE	(4 STROKE) OUTBOARD / (4 TIEMPOS) FUERABORDA
2 X 250 HP MERCURY V-8 VERADO	(4 STROKE) OUTBOARD / (4 TIEMPOS) FUERABORDA
2 X 300 HP MERCURY V-8 VERADO	(4 STROKE) OUTBOARD / (4 TIEMPOS) FUERABORDA

ACTIVE TRIM MERCURY MARINE®  
JOYSTICK PILOTING SYSTEM (JPO) MERCURY

## STANDARD EQUIPMENT / EQUIPAMIENTO DE SERIE

WHITE COLOR HULL WITH SOFT-TOP	CASCO COLOR BLANCO CON SOFT-TOP
ARTIFICIAL TEAK DECK FLEXITEEK® SCRUBBED WITH BLACK LINES	CUBIERTA DE TECA SINTÉTICA FLEXITEEK® SCRUBBED Y LINEAS NEGRAS
ANCHOR SUPPORT, ANCHOR, CHAIN AND ELECTRIC WINCH	SOPORTE DE ANCLA, ANCLA, CADENA Y MOLINETE ELÉCTRICO
LED NAVIGATION LIGHTS	LUCES DE NAVEGACIÓN LED
LED DECORATIVE LIGHTS ON DECK	LUCES DECORATIVAS LED EN CUBIERTA
TABLE DECK	MESA DE CUBIERTA
SWIMMING LADDER	ESCALERA DE BAÑO
CARBON TRIMS ON BOWS AND REAR SPEAKERS	EMBELLECEDORES DE CARBONO EN LAS AMURAS Y ALTAVOCES POSTERIORES
FIBER FLAGPOLE	ASTA DE BANDERA
RETRACTABLE CLEATS IN ALUMINIUM	CORNAMUSAS RETRÁCTILES DE ALUMINIO
COMPLETE KITCHEN EXTERIOR (FRIDGE 49L, SINK, VITROCERAMIC COOKTOP)	COCINA EXTERIOR (NEVERA 49L, FREGADERO, PLACA VITROCERÁMICA)
OUTLET 12V	ENCHUFE 12V (USB Y MECHERO)
CUSHION AND UPHOLSTERY PREMIUM MORBERN SUNDANCE® HERM	COJINES Y TAPICERÍA PREMIUM MORBERN SUNDANCE®HERM
AUDIO SYSTEM FUSION RA-60 (4 SPEAKERS)	SISTEMA DE AUDIO FUSION SERIE RA-60 (4 ALTAVOCES)
NAVIGATION SYSTEM SIMRAD (12")	SISTEMA DE NAVEGACIÓN SIMRAD (12")
PILOT BENCH SEATS IN MORBERN ALLANTE® GREY UPHOLSTERY	ASIENTOS BANCO PILOTO EN TAPICERÍA MORBERN ALLANTE® GREY
HORN	BOCINA
BILGE PUMPS	BOMBAS DE ACHIQUE
AC SHORE POWER AND CABLE / BATTERY CHARGER	TOMA DE TIERRA Y CABLE / CARGADOR DE BATERÍA
SHOWER ON DECK	DUCHA AGUA DULCE EN CUBIERTA
WINDOWS ON HULL SIDES (STERN AND BOW CABIN)	VENTANAS LATERALES EN CASCO (CABINA POPA Y PROA)
BOW CABIN WITH DOUBLE BED	CABINA EN PROA CON CAMA DOBLE
STERN CABIN	CABINA EN POPA
COMPLETE BATHROOM (ELECTRIC WC)	BAÑO COMPLETO (WC ELÉCTRICO)

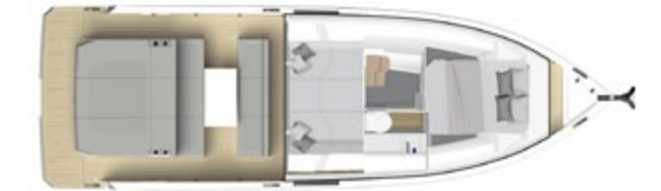



# D36

O P E N

The D36 is the new mid-size model in the range that gathers together the brand's experience in the development of the latest models and concentrates in a single version the best of the successful D34 in its Open and Cruiser variants.

A very complete boat in its length, with a high-performance hull with a pronounced V and two lines of steps, a large space on the deck with a walkaround distribution with an innovative modular interior and a complete independent bathroom. The options "Hardtop" and "High windshield" offer the possibility of configuring a semi cabin version where you can navigate protected.

An evolved, sophisticated and sporty design. An avant-garde boat that will set a trend.

*El D36 es el nuevo modelo medio de la gama que recoge la experiencia de la marca en el desarrollo de los últimos modelos y concentra en una sola versión lo mejor del exitoso D34 en sus variantes Open y Cruiser.*

*Un barco muy completo en su eslora, con un casco de alto rendimiento de pronunciada V y dos líneas de "steps", gran espacio en cubierta con distribución "walkaround" con un innovador interior modulable y un completo baño independiente. Los opcionales "Hardtop" y "Parabrisas alto" ofrecen la posibilidad de configurar una versión semi cabinada dónde poder navegar protegido.*

*Un evolucionado diseño, sofisticado y deportivo. Un barco de vanguardia que marcará tendencia.*

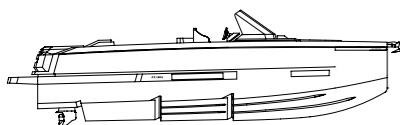



## TECHNICAL SPECIFICATIONS / ESPECIFICACIONES TÉCNICAS

LENGTH OVERALL / <i>ESLORA TOTAL</i>	10,30 m	MINIMUM POWER / <i>POTENCIA MÍNIMA</i>	600 HP
LENGTH OVERALL WITH PLATFORM XL OPTION / <i>ESLORA TOTAL CON PLATAFORMA XL OPCIONAL</i>	11,15 m	MAXIMUM POWER / <i>POTENCIA MÁXIMA</i>	900 HP
BEAM / <i>MANGA</i>	3,40 m	FUEL TANK / <i>DEPÓSITO DE COMBUSTIBLE</i>	850 L
DEPTH / <i>CALADO</i>	0,70 m	WATER TANK / <i>DEPÓSITO DE AGUA DULCE</i>	150 L
PASSENGERS / <i>OCUPANTES</i>	12 pax	DISPLACEMENT / <i>DESPLAZAMIENTO</i>	5.300 Kg
OUTBOARD ENGINES / <i>MOTORES FUERABORDA</i>	2 uds.		

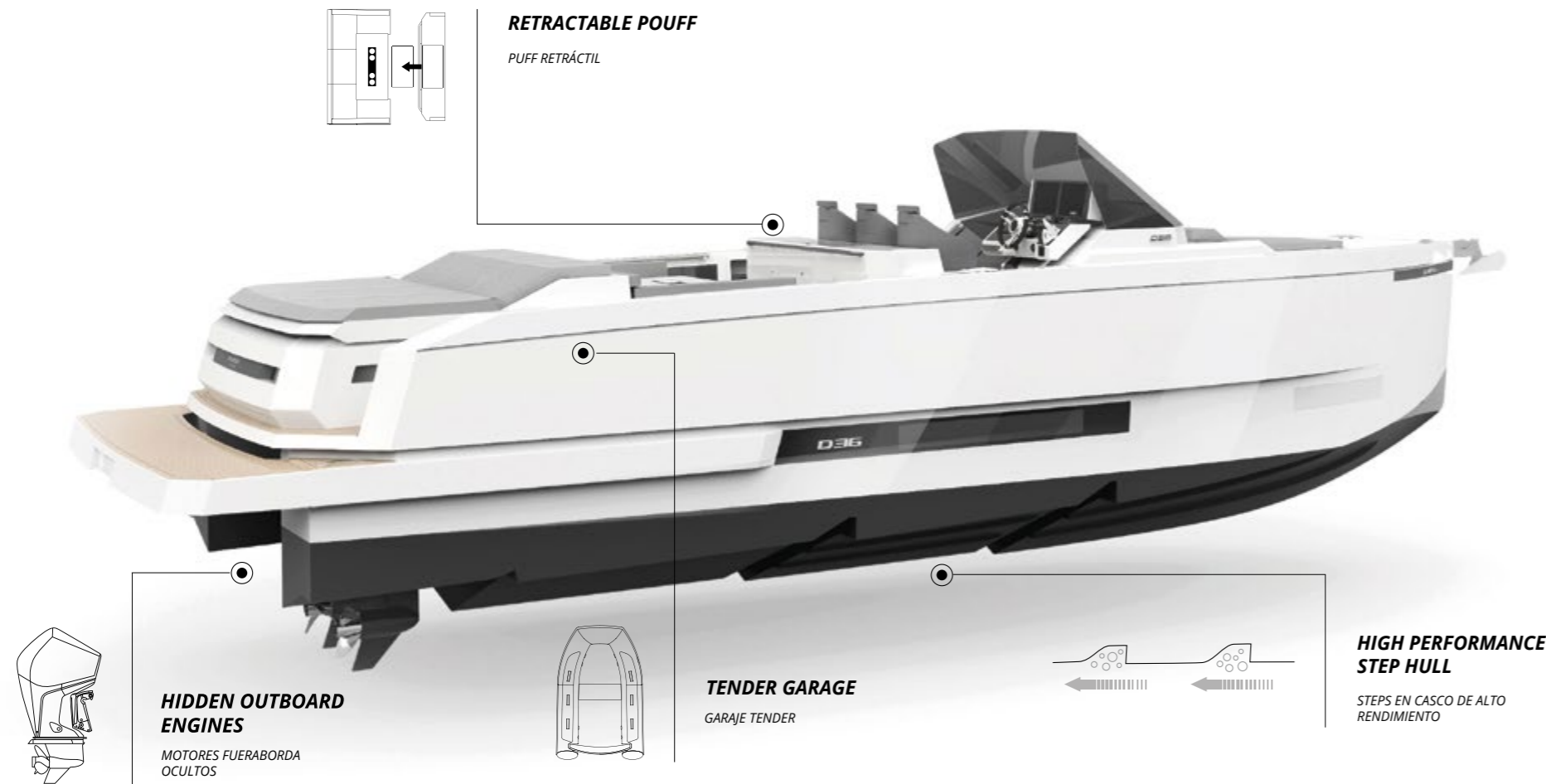

## MOTORIZATION / MOTORIZACIÓN

2 X 300 HP MERCURY V-8 VERADO®	(4 STROKE) OUTBOARD / (4 TIEMPOS) FUERABORDA
2 X 350 HP MERCURY V-10 VERADO®	(4 STROKE) OUTBOARD / (4 TIEMPOS) FUERABORDA
2 X 400 HP MERCURY V-10 VERADO®	(4 STROKE) OUTBOARD / (4 TIEMPOS) FUERABORDA
<b>ACTIVE TRIM MERCURY MARINE®</b>	
JOYSTICK PILOTING SYSTEM (JPO) MERCURY (OPTIONAL)	

## STANDARD EQUIPMENT / EQUIPAMIENTO DE SERIE

WHITE COLOR HULL	CASCO COLOR BLANCO
ARTIFICIAL TEAK DECK FLEXITEEK® SCRUBBED WITH BLACK LINES	CUBIERTA DE TECA SINTÉTICA FLEXITEEK® SCRUBBED Y LÍNEAS NEGRAS
ANCHOR SUPPORT, ANCHOR, CHAIN AND ELECTRIC WINCH	SOPORTE DE ANCLA, ANCLA, CADENA Y MOLINETE ELÉCTRICO
LED NAVIGATION LIGHTS	LUCES DE NAVEGACIÓN LED
LED DECORATIVE LIGHTS ON DECK	LUCES DECORATIVAS LED EN CUBIERTA
TABLE ON DECK	MESA DE CUBIERTA
SWIMMING LADDER	ESCALERA DE BAÑO
CARBON TRIMS ON BOWS	EMBELLECEDORES DE CARBONO EN LAS AMURAS
FLAGPOLE	ASTA DE BANDERA
USB PLUG 12 V OUTLET	ENCHUFE USB 12V
EXTERIOR KITCHEN (FRIDGE, SINK, VITROCERAMIC COOKTOP)	COCINA EXTERIOR (NEVERA, FREGADERO, PLACA VITROCERÁMICA)
PILOT BENCH SEATS IN MORBERN ALLANTE® GREY UPHOLSTERY	ASIENTOS BANCO PILOTO EN TAPICERÍA MORBERN ALLANTE® GREY
CUSHION AND PREMIUM UPHOLSTERY MORBERN SUNDANCE® HERM	TAPICERÍA PREMIUM MORBERN SUNDANCE® HERM
RETRACTABLE CLEATS IN ALUMINIUM	CORNAMUSAS RETRÁCTILES DE ALUMINIO
AUDIO SYSTEM FUSION RA60 (4 SPEAKERS)	SISTEMA DE AUDIO FUSION RA60 (4 ALTAVOCES)
NAVIGATION SYSTEM SIMRAD (9")	SISTEMA DE NAVEGACIÓN SIMRAD (9")
HORN	BOCINA
BILGE PUMPS	BOMBAS DE ACHIQUE
AC SHORE POWER AND CABLE / BATTERY CHARGER	TOMA DE TIERRA Y CABLE / CARGADOR DE BATERÍA
SHOWER ON DECK	DUCHA AGUA DULCE EN CUBIERTA
WINDOWS ON HULL SIDES (STERN AND BOW CABIN)	VENTANAS LATERALES EN CASCO (CABINA POPA Y PROA)
BOW CABIN WITH DOUBLE BED (140 CM X 190 CM)	CABINA EN PROA CON CAMA DOBLE (140 X 190 CM)
STERN CABIN WITH TRIPLE BED IN U SHAPE	CABINA EN POPA CON CAMA TRIPLE EN FORMA DE U
COMPLETE BATHROOM (ELECTRIC WC)	BAÑO COMPLETO (WC ELÉCTRICO)



de antonio  
YACHTS



OFFICIAL SUPPLIER

## D37

ALINGHI RED BULL RACING

The D37 Alinghi Red Bull Racing is a tribute to the prestigious sailing racing team Alinghi, winner of the America's Cup representing the Swiss club Société Nautique de Genève.

The participation in the 37th Edition of the America's Cup to be held in Barcelona in 2024, has led to the collaboration of De Antonio Yachts with the team to create a special design for a Limited Edition of 37 exclusive units.

The model is equipped with two Mercury 400hp Racing version engines that give it a high performance of sportiness in navigation. Its exterior and interior, in full navy blue, the official color of the team, combined with red details, special upholstery finishes, as well as bucket seats and steering wheel in navy blue leather and red stitching and numerous details in carbon fiber and inscriptions with the logos of the racing team make this version, the perfect model for fans of the team and lovers of limited editions who appreciate the value of unique pieces.

*El D37 Alinghi Red Bull Racing es un tributo al prestigioso equipo de regatas a vela Alinghi, ganador de la America's Cup representando al club suizo Société Nautique de Genève.*

*En motivo de la participación en la 37th Edición de la America's Cup que se celebrará en Barcelona en 2024, De Antonio Yachts en colaboración con el equipo ha creado un diseño especial para una Edición Limitada de 37 exclusivas unidades.*

*El modelo equipa dos motores Mercury 400hp versión Racing que le confieren unas altas prestaciones de deportividad en la navegación. Su exterior e interior, en completo tono azul marino, color oficial del equipo, combinado con detalles en rojo, acabados de tapicería especiales, así como asientos tipo bucket y volante en piel azul marino y pespunte en rojo y numerosos detalles en fibra de carbono e inscripciones con los logos del equipo de competición hacen de esta versión, el modelo perfecto para los fans del equipo y los amantes de ediciones limitadas que saben apreciar el valor de piezas únicas.*







# D42

O P E N

The D42 offers the best of navigation with an incomparable stern platform and the option of being able to regulate its height and adjust it to the sea level. Its spectacular walk-around design with large sundecks, a lounge area convertible in 3 different configurations, together with the exterior kitchen, make it unique. The D42 exceeds all expectations, with its interior habitability that stands out for its spaciousness, smart solutions such as a central garage for a small tender, and finally the successful and recognized brand innovation of hidden outboard motorization. An ideal 12-meter family cruiser with sporty features and an exceptional design.

*El D42 ofrece lo mejor de la navegación con una incomparable plataforma de popa y con la opción de poder regular su altura para ajustarla hasta el nivel del mar. Su espectacular diseño walkaround con grandes solárium, la zona de estar tipo lounge y convertible en tres configuraciones distintas junto a la cocina exterior lo hacen único. El D42 supera todas las expectativas, con su habitabilidad interior que se destaca por su amplitud, soluciones como un garaje central para una pequeña auxiliar junto a la exitosa y reconocida innovación de la marca en la motorización fueraborda oculta. Un ideal crucero familiar de 12 metros con prestaciones deportivas y un diseño excepcional.*

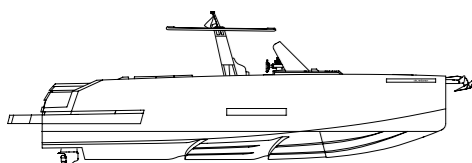



## TECHNICAL SPECIFICATIONS / ESPECIFICACIONES TÉCNICAS

LENGTH OVERALL / <i>ESLORA TOTAL</i>	12,10 m	MINIMUM POWER / <i>POTENCIA MÍNIMA</i>	900 HP
LENGTH OVERALL WITH PLATFORM XL OPTION / <i>ESLORA TOTAL CON PLATAFORMA XL OPCIONAL</i>	12,64 m	MAXIMUM POWER / <i>POTENCIA MÁXIMA</i>	1.200 HP
BEAM / <i>MANGA</i>	3,99 m	FUEL TANK / <i>DEPÓSITO DE COMBUSTIBLE</i>	1.300 L
DEPTH / <i>CALADO</i>	0,70 m	WATER TANK / <i>DEPÓSITO DE AGUA DULCE</i>	250 L
PASSENGERS / <i>OCUPANTES</i>	12 pax	DISPLACEMENT / <i>DESPLAZAMIENTO</i>	7.600 Kg
OUTBOARD ENGINES / <i>MOTORES FUERABORDA</i>	3 uds.		



## MOTORIZATION / MOTORIZACIÓN

3 X 300 HP MERCURY V-8 VERADO®	(4 STROKE) OUTBOARD / (4 TIEMPOS) FUERABORDA
3 X 350 HP MERCURY V-10 VERADO®	(4 STROKE) OUTBOARD / (4 TIEMPOS) FUERABORDA
3 X 400 HP MERCURY V-10 VERADO®	(4 STROKE) OUTBOARD / (4 TIEMPOS) FUERABORDA
ACTIVE TRIM MERCURY MARINE®	
JOYSTICK PILOTING SYSTEM (JPO) MERCURY® (OPTIONAL)	

## STANDARD EQUIPMENT / EQUIPAMIENTO DE SERIE

WHITE COLOR HULL	CASCO COLOR BLANCO
ARTIFICIAL TEAK DECK FLEXITEEK® SCRUBBED WITH BLACK LINES	CUBIERTA DE TECA SINTÉTICA FLEXITEEK® SCRUBBED Y LÍNEAS NEGRAS
ANCHOR SUPPORT, ANCHOR, CHAIN AND ELECTRIC WINCH	SOPORTE DE ANCLA, ANCLA, CADENA Y MOLINETE ELÉCTRICO
SOFT-TOP	SOFT-TOP
LED NAVIGATION LIGHTS LOPOLIGHT®	LUCES DE NAVEGACIÓN LED LOPOLIGHT®
LED DECORATIVE LIGHTS ON DECK	LUCES DECORATIVAS LED EN CUBIERTA
TWO RETRACTABLE TABLES	DOS MESAS RETRACTILES
SWIMMING LADDER	ESCALERA DE BAÑO
CARBON TRIMS ON BOWS AND SIDES	EMBELLECEDORES DE CARBONO EN LAS AMURAS Y COSTADOS
FLAGPOLE	ASTA DE BANDERA
RETRACTABLE CLEATS IN ALUMINIUM	CORNAMUSAS RETRACTILES DE ALUMINIO
COMPLETE KITCHEN (FRIDGE, SINK, CERAMIC COOKTOP, MICROWAVE)	COCINA (NEVERA, FREGADERO, VITROCERÁMICA, MICROONDAS)
CUSHIONS AND UPHOLSTERY MORBERN SUNDANCE® HERM	COJINES Y TAPICERÍA MORBERN SUNDANCE® HERM
HANDHOLDS WITH MORBERN SUNDANCE® FINISHES	ASIDEROS CON ACABADOS EN MORBERN SUNDANCE®
AUDIO SYSTEM FUSION R470N (4 SPEAKERS)	SISTEMA DE AUDIO FUSION R470N (4 ALTAVOCES)
NAVIGATION SYSTEM SIMRAD (12")	SISTEMA DE NAVEGACIÓN SIMRAD (12")
VHF RADIO SIMRAD RS20 AND ANTENNA	RADIO VHF SIMRAD RS20 Y ANTENA
USB PLUG 12 V OUTLET	ENCHUFE USB 12V
HORN	BOCINA
BILGE PUMPS	BOMBAS DE ACHIQUE
AC SHORE POWER AND CABLE / BATTERY CHARGER	TOMA DE TIERRA Y CABLE / CARGADOR DE BATERÍA
SHOWER ON DECK	DUCHA AGUA DULCE EN CUBIERTA
WINDOWS ON HULL SIDES (STERN CABIN)	VENTANAS LATERALES EN CASCO (CABINA POPA)
BOW CABIN WITH DOUBLE BED (140 X 190 CM)	CABINA EN PROA CON CAMA DOBLE (140 X 190 CM)
STERN CABIN WITH U SHAPE TRIPLE BED (250 X 300 X 250 CM)	CABINA EN POPA CON SOFA EN U-CAMA TRIPLE (250 X 300 X 250 CM)
COMPLETE BATHROOM (ELECTRIC WC)	BAÑO COMPLETO (WC ELÉCTRICO)





# D50

O P E N

The D50 Open, is the ultimate in on-board performance and comfort. Based on the award-winning D46 Open and equipped with 2, 3 or 4 hidden outboard engines, it delivers unrivalled sporty and efficient cruising, exceeding 50 knots with a maximum power output of 1,800hp. Its deck layout offers impressive relaxation areas including the optional convertible Jacuzzi on the bow sundeck.

The interior layout is customizable with 2 or 3 cabins, one of which can be adapted as a skipper's cabin, also offering the option of 1 or 2 bathrooms.

*El D50 Open, es el máximo exponente de rendimiento y confort a bordo. Basado en el premiado D46 Open y equipado con 2, 3 o 4 motores fueraborda ocultos, proporciona una navegación deportiva y eficiente sin igual, superando los 50 nudos con una potencia máxima de 1.800cv. Su distribución en cubierta ofrece incluso el opcional de un jacuzzi convertible en el solárium de proa.*

*La distribución interior personalizable, con 2 o 3 camarotes, uno de ellos adaptable como cabina de patrón, ofreciendo también la opción de 1 o 2 baños.*

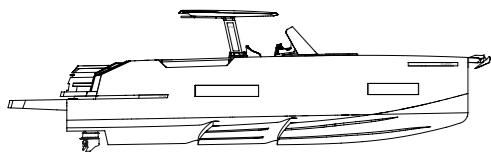



## TECHNICAL SPECIFICATIONS / ESPECIFICACIONES TÉCNICAS

LENGTH OVERALL / <i>ESLORA TOTAL</i>	13,10 m	MINIMUM POWER / <i>POTENCIA MÍNIMA</i>	1.200 HP
LENGTH OVERALL WITH PLATFORM OPTION / <i>ESLORA TOTAL CON PLATAFORMA OPCIONAL</i>	14,90 m	MAXIMUM POWER / <i>POTENCIA MÁXIMA</i>	1.600 HP
BEAM / <i>MANGA</i>	4,40 m	FUEL TANK / <i>DEPÓSITO DE COMBUSTIBLE</i>	1.500 L
DEPTH / <i>CALADO</i>	0,70 m	WATER TANK / <i>DEPÓSITO DE AGUA DULCE</i>	350 L
PASSENGERS / <i>OCUPANTES</i>	12 pax	DISPLACEMENT / <i>DESPLAZAMIENTO</i>	11.000 Kg
OUTBOARD ENGINES / <i>MOTORES FUERABORDA</i>	2 o 4 uds.		

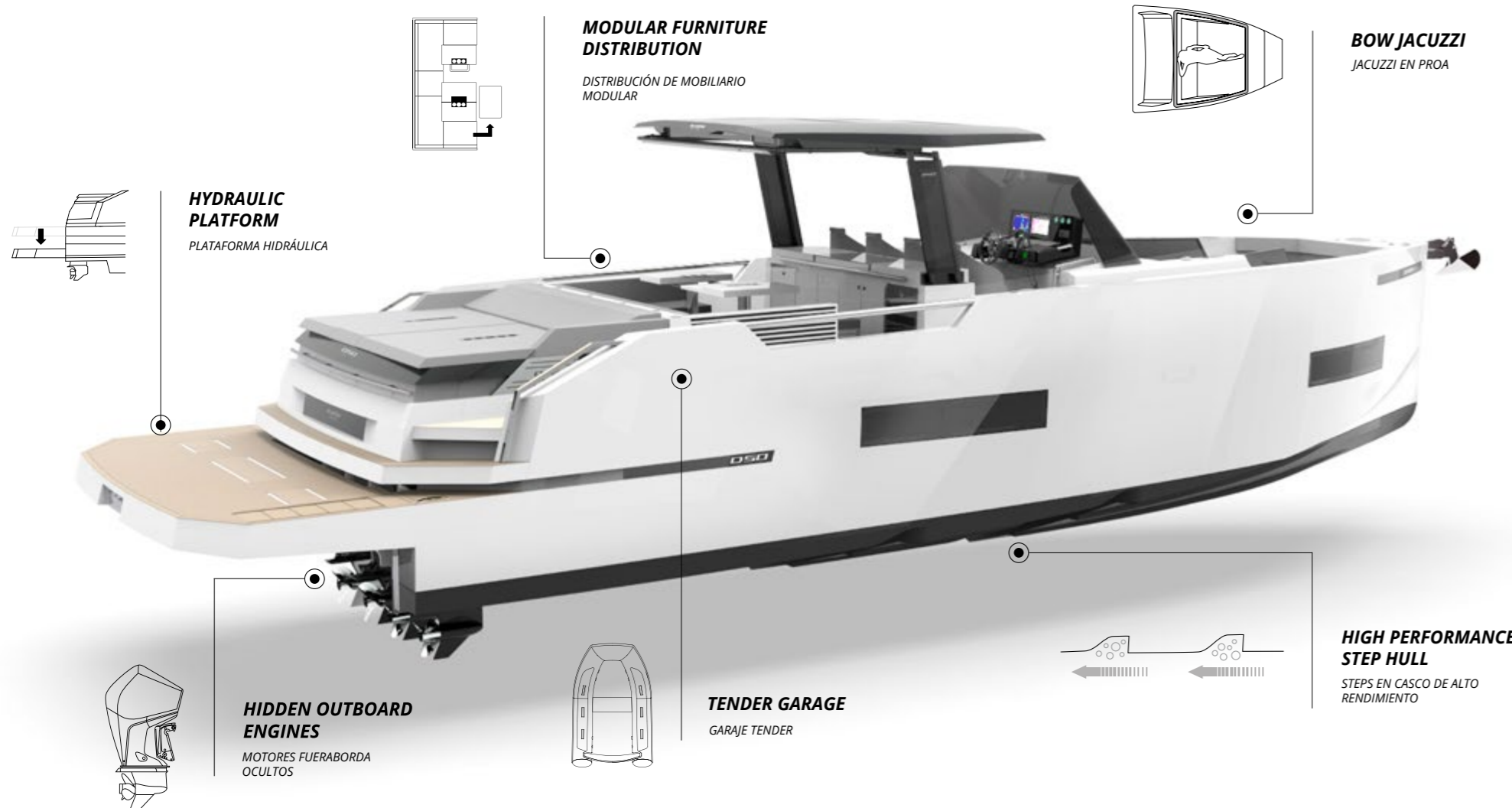

## MOTORIZATION / MOTORIZACIÓN

2 X 600 HP MERCURY V-12 VERADO®	(4 STROKE) OUTBOARD / (4 TIEMPOS) FUERABORDA
4 X 300 HP MERCURY V-8 VERADO®	(4 STROKE) OUTBOARD / (4 TIEMPOS) FUERABORDA
4 X 350 HP MERCURY V-10 VERADO®	(4 STROKE) OUTBOARD / (4 TIEMPOS) FUERABORDA
4 X 400 HP MERCURY V-10 VERADO®	(4 STROKE) OUTBOARD / (4 TIEMPOS) FUERABORDA

ACTIVE TRIM MERCURY MARINE  
JOYSTICK PILOTING SYSTEM (JPO) MERCURY (OPTIONAL)

## STANDARD EQUIPMENT / EQUIPAMIENTO DE SERIE

WHITE COLOR HULL	CASCO COLOR BLANCO
ARTIFICIAL TEAK DECK FLEXITEEK® SCRUBBED WITH BLACK LINES	CUBIERTA DE TECA SINTÉTICA FLEXITEEK® SCRUBBED Y LÍNEAS NEGRAS
ANCHOR SUPPORT, ANCHOR, CHAIN AND ELECTRIC WINCH	SOPORTE DE ANCLA, ANCLA, CADENA Y MOLINETE ELÉCTRICO
SOFT-TOP	SOFT -TOP
LED NAVIGATION LIGHTS LOPOLIGHT®	LUCES DE NAVEGACIÓN LED LOPOLIGHT®
LED DECORATIVE LIGHTS ON DECK	LUCES DECORATIVAS LED EN CUBIERTA
TWO TABLES ON DECK	DOS MESAS EN CUBIERTA
SWIMMING LADDER	ESCALERA DE BAÑO
CARBON TRIMS ON BOWS AND SIDES	EMBELLECEDORES DE CARBONO EN LAS AMURAS Y COSTADOS
FLAGPOLE	ASTA DE BANDERA
RETRACTABLE CLEATS IN ALUMINIUM	CORNAMUSAS RETRÁCTILES DE ALUMINIO
EXTERIOR KITCHEN (FRIDGE, SINK, CERAMIC COOKTOP, MICROWAVE)	COCINA (NEVERA, FREGADERO, VITROCERÁMICA, MICROONDAS)
CUSHIONS AND UPHOLSTERY MORBERN SUNDANCE® HERM	COJINES Y TAPICERÍA MORBERN SUNDANCE® HERM
AUDIO SYSTEM FUSION R470N (4 SPEAKERS)	SISTEMA DE AUDIO FUSION R470N (4 ALTAVOCES)
NAVIGATION SYSTEM SIMRAD (12")	SISTEMA DE NAVEGACIÓN SIMRAD (12")
VHF RADIO SIMRAD RS20 AND ANTENNA	RADIO VHF SIMRAD RS20 Y ANTENA
HORN	BOCINA
BILGE PUMPS	BOMBAS DE ACHIQUE
AC SHORE POWER AND CABLE / BATTERY CHARGER	TOMA DE TIERRA Y CABLE / CARGADOR DE BATERÍA
SHOWER ON DECK	DUCHA AGUA DULCE EN CUBIERTA
WINDOWS ON HULL SIDES (STERN CABIN)	VENTANAS LATERALES EN CASCO (CABINA POPA)
BOW CABIN WITH DOUBLE BED	CABINA EN PROA CON CAMA DOBLE
LIVING AREA WITH U-SHAPED SOFA CONVERTIBLE INTO DOUBLE BED	SALÓN EN POPA, SOFÁ EN FORMA DE U CONVERTIBLE EN CAMA DOBLE
COMPLETE BATHROOM (ELECTRIC WC)	BAÑO COMPLETO (WC ELÉCTRICO)
USB AND LIGHTER PLUG OUTLET 12V	ENCHUFE 12V (USB Y MECHERO)



2 cabins + Modular distribution **opt.** 1 living room



2 cabins + Modular distribution **opt.** 2 bedroom



3 cabins + 2 bathrooms



2 cabins + 1 skipper cabin - 1 bathroom





# D50

C O U P É

The D50 Coupé is the latest model in the range, a design that exceeds all expectations in its length and re-invents the walkaround concept.

Based on the D50 Open, it maintains its impressive navigation performance with hidden outboards and the characteristic and generous spaces both on deck and inside. This new version with a slim superstructure further highlights its avant-garde architecture by offering its occupants a closed driving area for greater comfort on long journeys and allowing its central part to be opened with the retractable canvas roof.

Sporty, modern, spacious and convertible, that's the D50 Coupé.

*El D50 Coupé es el último modelo de la gama, un diseño que supera todas las expectativas en su eslora y reinventa el concepto walkaround.*

*Basado en el D50 Open, mantiene sus impresionantes prestaciones de navegación con motores fueraborda ocultos y los característicos y generosos espacios tanto en cubierta como en el interior. Esta nueva versión con una estilizada superestructura resalta aún más su arquitectura vanguardista ofreciendo a sus ocupantes una zona de conducción cerrada para mayor confort en trayectos largos y permitiendo en su parte central abrirse con el techo retráctil de lona.*

*Deportivo, moderno, espacioso y cabrio, así es el D50 Coupé.*

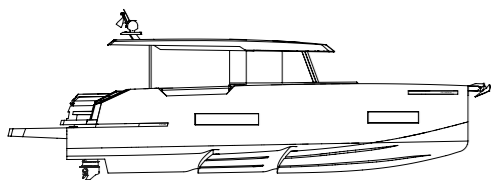





## TECHNICAL SPECIFICATIONS / ESPECIFICACIONES TÉCNICAS

LENGTH OVERALL / <i>ESLORA TOTAL</i>	13,10 m	MINIMUM POWER / <i>POTENCIA MÍNIMA</i>	1.200 HP
LENGTH OVERALL WITH PLATFORM OPTION / <i>ESLORA TOTAL CON PLATAFORMA OPCIONAL</i>	14,90 m	MAXIMUM POWER / <i>POTENCIA MÁXIMA</i>	1.600 HP
BEAM / <i>MANGA</i>	4,40 m	FUEL TANK / <i>DEPÓSITO DE COMBUSTIBLE</i>	1.500 L
DEPTH / <i>CALADO</i>	0,70 m	WATER TANK / <i>DEPÓSITO DE AGUA DULCE</i>	350 L
PASSENGERS / <i>OCUPANTES</i>	12 pax	DISPLACEMENT / <i>DESPLAZAMIENTO</i>	12.000 Kg
OUTBOARD ENGINES / <i>MOTORES FUERABORDA</i>	2 o 4 uds.		

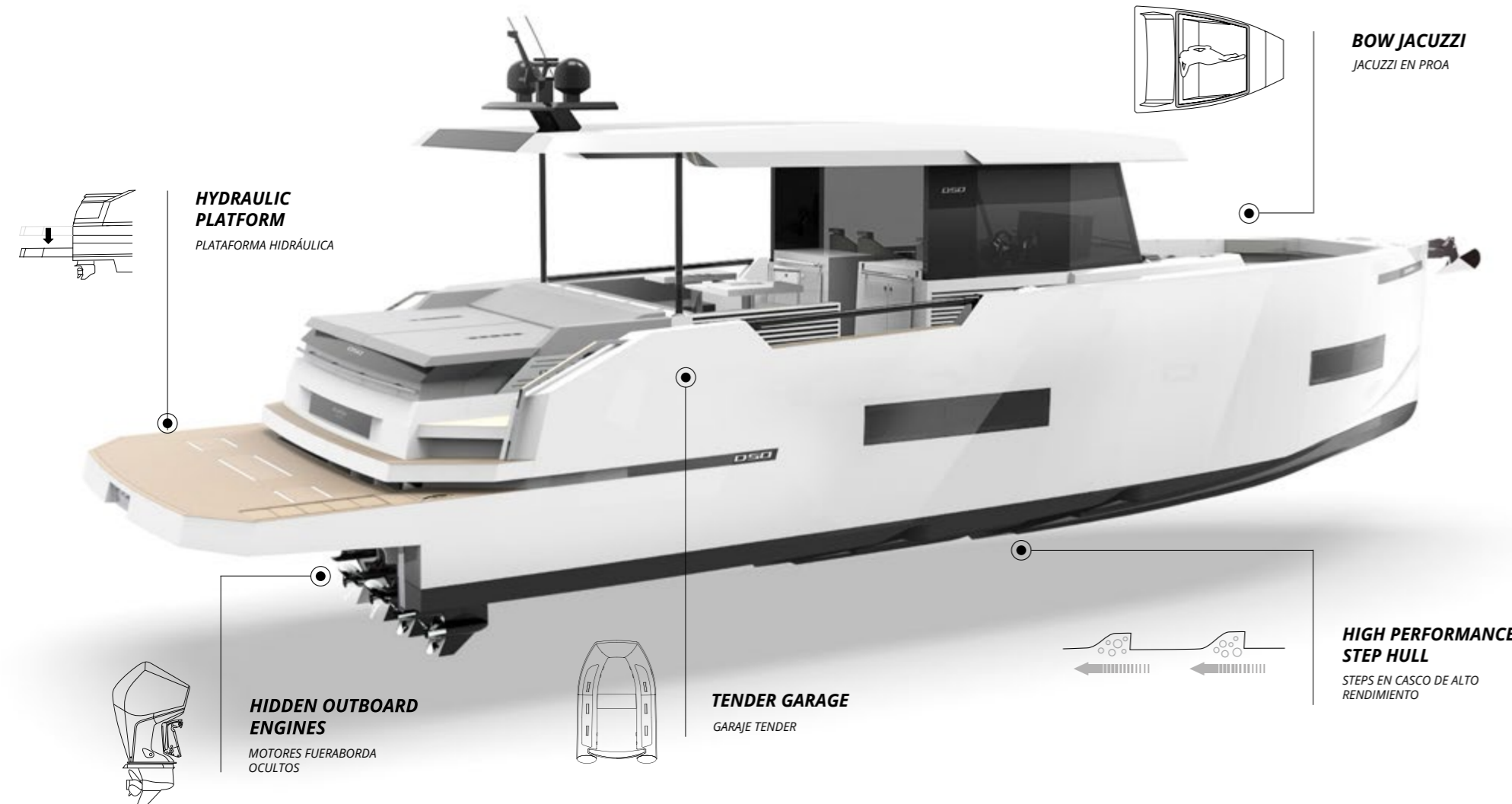

## MOTORIZATION / MOTORIZACIÓN

2 X 600 HP MERCURY V-12 VERADO®	(4 STROKE) OUTBOARD / (4 TIEMPOS) FUERABORDA
4 X 300 HP MERCURY V-8 VERADO®	(4 STROKE) OUTBOARD / (4 TIEMPOS) FUERABORDA
4 X 350 HP MERCURY V-10 VERADO®	(4 STROKE) OUTBOARD / (4 TIEMPOS) FUERABORDA
4 X 400 HP MERCURY V-10 VERADO®	(4 STROKE) OUTBOARD / (4 TIEMPOS) FUERABORDA
ACTIVE TRIM MERCURY MARINE	
JOYSTICK PILOTING SYSTEM (JPO) MERCURY (OPTIONAL)	

## STANDARD EQUIPMENT / EQUIPAMIENTO DE SERIE

WHITE COLOR HULL	CASCO COLOR BLANCO
ARTIFICIAL TEAK DECK FLEXITEEK® SCRUBBED WITH BLACK LINES	CUBIERTA DE TECA SINTÉTICA FLEXITEEK® SCRUBBED Y LÍNEAS NEGRAS
ANCHOR SUPPORT, ANCHOR, CHAIN AND ELECTRIC WINCH	SOPORTE DE ANCLA, ANCLA, CADENA Y MOLINETE ELÉCTRICO
LED NAVIGATION LIGHTS LOPOLIGHT®	LUCES DE NAVEGACIÓN LED LOPOLIGHT®
LED DECORATIVE LIGHTS ON DECK	LUCES DECORATIVAS LED EN CUBIERTA
TWO TABLES ON DECK	DOS MESAS EN CUBIERTA
SWIMMING LADDER	ESCALERA DE BAÑO
CARBON TRIMS ON BOWS AND SIDES	EMBELLECEDORES DE CARBONO EN LAS AMURAS Y COSTADOS
FLAGPOLE	ASTA DE BANDERA
RETRACTABLE CLEATS IN ALUMINIUM	CORNAMUSAS RETRACTILES DE ALUMINIO
EXTERIOR KITCHEN (FRIDGE, SINK, CERAMIC COOKTOP, MICROWAVE)	COCINA (NEVERA, FREGADERO, VITROCERÁMICA, MICROONDAS)
CUSHIONS AND UPHOLSTERY MORBERN SUNDANCE® HERM	COJINES Y TAPICERÍA MORBERN SUNDANCE® HERM
AUDIO SYSTEM FUSION R470N (4 SPEAKERS)	SISTEMA DE AUDIO FUSION R470N (4 ALTAVOCES)
NAVIGATION SYSTEM SIMRAD (12")	SISTEMA DE NAVEGACIÓN SIMRAD (12")
VHF RADIO SIMRAD RS20 AND ANTENNA	RADIO VHF SIMRAD RS20 Y ANTENA
HORN	BOCINA
BILGE PUMPS	BOMBAS DE ACHIQUE
AC SHORE POWER AND CABLE / BATTERY CHARGER	TOMA DE TIERRA Y CABLE / CARGADOR DE BATERÍA
SHOWER ON DECK	DUCHA AGUA DULCE EN CUBIERTA
WINDOWS ON HULL SIDES (STERN CABIN)	VENTANAS LATERALES EN CASCO (CABINA POPA)
BOW CABIN WITH DOUBLE BED	CABINA EN PROA CON CAMA DOBLE
LIVING AREA WITH U-SHAPED SOFA CONVERTIBLE INTO DOUBLE BED	SALÓN EN POPA, SOFÁ EN FORMA DE U CONVERTIBLE EN CAMA DOBLE
COMPLETE BATHROOM (ELECTRIC WC)	BAÑO COMPLETO (WC ELÉCTRICO)
USB AND LIGHTER PLUG OUTLET 12V	ENCHUFE 12V (USB Y MECHERO)



2 cabins + Modular distribution **opt.** 1 living room



2 cabins + Modular distribution **opt.** 2 bedroom



3 cabins + 2 bathrooms



2 cabins + 1 skipper cabin - 1 bathroom



2 cabins + 1 skipper cabin - 1 bathroom

**CUSTOMIZATION/ PERSONALIZACIÓN**

It's time to customize your dream boat. Choose from our wide variety of colours combinations from top suppliers and make your De Antonio Yachts according to your individual wishes. Your boat, your style.

*Es hora de personalizar el barco de sus sueños. Elija entre nuestra amplia variedad de combinaciones de colores de los principales proveedores y cree su De Antonio Yachts de acuerdo con sus deseos. Su barco, su estilo.*

**UPHOLSTERY COLOURS / COLORES DE TAPICERÍA MORBERN SUNDANCE®**

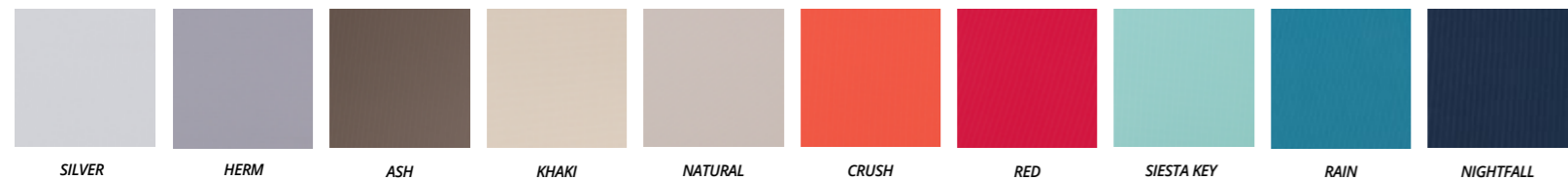

**UPHOLSTERY FINISHES / ACABADOS DE TAPICERÍA**

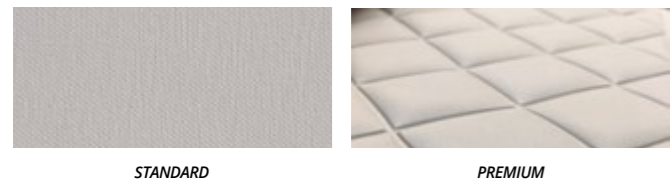

**TEAK / TECA FLEXITEEK®**

Choose your best teak and line color combination from the different options / *Elija la mejor combinación de color de teca y línea entre las distintas opciones.*

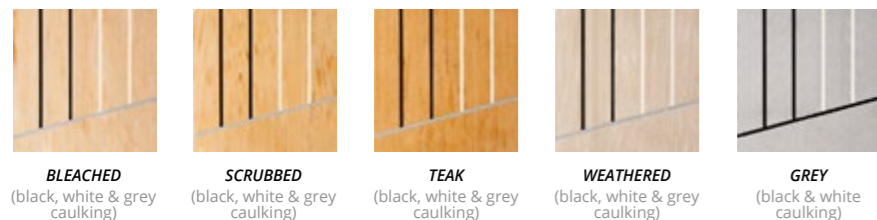

**GELCOAT OPTIONS / OPCIONES DE GELCOAT**

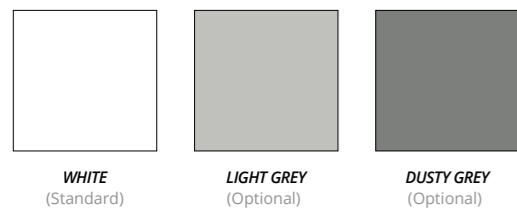

**D28 FORMENTOR**

e - H Y B R I D



de Antonio  
YACHTS



 **SPAIN****BARCELONA & TARRAGONA**  
DRACO SERVICIOS NÁUTICOS

Calle Dr. Fleming 6, bajos  
08017 Barcelona  
alvaro@deantonioyachts.com  
+34 938 32 33 33

**COSTA BRAVA SUR**  
NÀUTICA CASAS

Av. de Castell d'Aro, 114  
17250 Platja d'Aro  
info@nauticacasas.com  
+34 972 81 76 12

**COSTA BRAVA NORTE**  
NAUTIVELA Viladamat-L'Escala

C. d'Orriols a l'Escala, km 16,6  
17137 Viladamat  
nautivela@nautivela.net  
+34 972 78 83 64  
+34 972 45 18 18

**ANDALUCÍA**  
HIGUERÓN YACHTS

Av. Del Higuero 48  
29640 Fuengirola - Málaga  
andalucia@deantonioyachts.com  
+34 609 00 86 80

**MALLORCA**  
CRISTAL YACHTS

Port Calanova Av. Juan Miró 37  
07015 Palma de Mallorca  
mallorca@deantonioyachts.com  
+34 620 28 32 12

**MENORCA**  
NAUTIC CENTER MENORCA

Calle S´ Esperó, 16 - Poima  
07714 Mahón - Menorca  
menorca@nauticcenter.es  
+34 971 35 44 99

**IBIZA & FORMENTERA**  
RENT ME BOAT

Paseo Juan Carlos I no. 23, local 10  
Edificio Mediterráneo - 07800 Ibiza  
ibiza@deantonioyachts.com  
+34 609 71 00 30

**VALENCIA**  
GRUPO PLEAMAR LEVANTE

Real Club Náutico de Valencia, Local 14  
Camino del Canal, 91  
46024 Valencia  
nauticservices@nauticservices.es  
+34 615 08 10 81

**DENIA**  
GRUPO PLEAMAR LEVANTE

Marina de Denia  
Edificio D, local 2  
03700 Denia  
comercial@pleamar.net  
+34 966 43 54 52

**MURCIA**  
GRUPO PLEAMAR LEVANTE

C.N Dos Mares  
Polígono Dos Mares, 37  
30380 La Manga del Mar Menor  
narcisoblaya@gmail.com  
+34 868 08 46 40

 **FRANCE****SAINT TROPEZ - THEOULE SUR MER**  
OMV - MERCURIO

319 Route des Blaquieres Bp 10  
83310 Grimaud  
info@omv.fr  
+33 (0) 4 94 555 333

**CANNES - NIZA**  
EVASION YACHTING

13, Quai Aristide Briand,  
83 430 Saint-Mandrier sur Mer  
info@evasion-yachting.com  
+33 (0)4 94 63 00 00

**MARSEILLE - CAVALAIRE SUR MER**  
EVASION YACHTING

13, Quai Aristide Briand,  
83 430 Saint-Mandrier sur Mer  
info@evasion-yachting.com  
+33 (0)4 94 63 00 00

**CORSE**  
UNION NAUTIQUE

Port de l'Amirauté  
20090 Ajaccio  
corse@deantonioyachts.com  
+33 (0)4 95 20 66 31

**CÔTE ATLANTIQUE**  
EVASION PRO YACHTING

N8 Quai Goslar  
33120 Arcachon  
arcachon@proyachting.net  
+33 5 64 52 00 00

 **ITALY****CENTRALE**  
PEDETTI YACHT SALES

Porto Turistico di Lavagna, box 102  
16033 Lavagna (GE)  
info@pedettiyacht.com  
dpedetti@pedettiyacht.com  
+39 0185 370164

**TRIVENETO**  
PEDETTI YACHT SALES

Via del Coregolo 32  
33053, Aprilia Marittima (UD)  
amichelazzo@pedettiyacht.com  
+39 3472 234548

**LAZIO, MARCHE ABRUZZO**  
PEDETTI YACHT SALES

Marina di Nettuno, box 11  
00048 Nettuno (LT)  
nettuno@pedettiyacht.com  
+39 3924 797325

**CAMPANIA**  
PEDETTI YACHT SALES

Via G. Cesare 86  
80070 Bacoli (NA)  
info@nauticafusaro.com  
+39 0818 689015

**SICILIA, CALABRIA**  
PEDETTI YACHT SALES

Marina di Portorosa, via Prestipaolo  
98054 Furnari (ME)  
siciliamare@siciliamare.it  
+39 337 886571

 **PORTUGAL****LISBOA**  
YB NAUTIC GROUP

Edf SGC, estrada de Alfragide 67  
2610-008 Lisboa, Portugal  
deantonioyachts@yb-nauticgroup.com  
+351 91 998 2530

 **SWITZERLAND****LEMAN LAKE**  
WOOD AND BOAT

24 route de Compois  
1252 Meinier GE  
a.lepine@deantonioyachts.com  
+41 (0)22 752 67 78

 **GERMANY****OFFENBACH AM MAIN**  
BAOTIC YACHTING GMBH

Andréstraße 2  
63067 Offenbach am Main  
info@baotic-yachting.de  
+ 49 (0) 69 829 78 80

 **CROATIA****SEGET DONJI**  
YACHT CENTAR BAOTIC D.O.O.  
MARINA BAOTIC

Don Petra Spike 2A 21218 Seget Donji  
info@baotic-yachting.de  
+ 49 (0) 69 829 78 80

 **SLOVENIA****ZAGREB**  
YACHT CENTAR BAOTIC D.O.O.

Maksimirska 282, 10 000 Zagreb  
info@baotic-yachting.de  
+49 (0) 69 829 78 80

 **MONACO****MONACO**  
HQ DE ANTONIO YACHTS

C/ del Avenir 8  
08006 Barcelona  
sales@deantonioyachts.com  
+34 93 467 60 36

  **FLORIDA & BAHAMAS****FT. LAUDERDALE**  
NAUTICAL VENTURES MARINE & SERVICE CENTER

1400 S. Federal Hwy, Fort Lauderdale, FL, 33316  
4470 Anglers Avenue Fort Lauderdale, FL, 33312  
sales@nauticalventures.com  
+1 (954) 926 5250

 **MEXICO****MEXICO CITY**  
PERFORMANCE BOATS MEXICO

Antonio Dovali Jaime 75 PB Lomas de Santa Fe  
C.P.01219, Mexico City  
ventas@pbt.com  
+52 55 5293 0563

 **BAHRAIN****KINGDOM OF BAHRAIN**  
DE ANTONIO YACHTS BAHRAIN

bahrain@deantonioyachts.com  
+973 36838300

    **THAILAND SINGAPORE MALAYSIA INDONESIA****FLOW YACHT CLUB**

20/169 Moo2, Kohkaew, Muang, Phuket  
83000 THAILAND  
info@flowyacht.club  
+66 96 55 99 554

 **AUSTRIA****OFFENBACH AM MAIN**  
BAOTIC YACHTING

Andréstraße 2  
63067 Offenbach am Main  
info@baotic-yachting.de  
+49 (0) 69 829 78 80

**SARASOTA**  
NAUTICAL VENTURES

8050 N. Tamiami Trail  
Sarasota, FL 34243  
sales@nauticalventures.com  
+1 (941) 355 5500

 **BRASIL****JACUECANGA**  
YB NAUTIC GROUP

Av. Winston Maruca, s/n, Lote 30 A/B  
Angra dos Reis - RJ - Zip Code 23.914-345  
deantonioyachts@yb-nauticgroup.com  
+55 24 998 142 481

 **TURKEY****BODRUM**  
BODRUM MARINE GROUP

Düzalan Cad, Ortakent Mah  
A Blok, No: 94-1/1, Bodrum  
info@bodrummarinegroup.com  
+90 252 358 7091

 **GREECE****ELLINIKO-ATHENS**  
ATALANTA MARINE

3 Iosifidou Street  
167 77 Elliniko - Athens  
shipyards@atalantamarine.com  
+30 210 991 0722

**TAMPA BAY**  
NAUTICAL VENTURES

1925 U.S. Highway 19  
Holiday, FL 34691  
sales@nauticalventures.com  
+1 (727) 939 8900

 **SAUDI ARABIA****JEDDAH**  
SAMACO MARINE

P.O. BOX #126417  
King Fahad road, Al Nahdah District  
21352 Jeddah  
s.marine@samaco.com.sa  
+96 612 699 23 00

 **AUSTRALIA****FERMANTLE**  
BOATINGCO

6/24 Mews Road, South Fremantle  
P.O.BOX 6162 Western Australia  
steve.marris@boatingco.com.au  
+61 430 118 442

 **CYPRUS****LIMASSOL**  
ATALANTA MARINE

3 Iosifidou Street  
167 77 Elliniko - Athens  
shipyards@atalantamarine.com  
+30 210 991 0722

**PALM BEACH**  
NAUTICAL VENTURES

139 Shore Ct  
North Palm Beach, FL 33408  
sales@nauticalventures.com  
+1 (561) 612 7076

 **KUWAIT****JEDDAH**  
SAMACO MARINE

P.O. BOX #126417  
King Fahad road, Al Nahdah District  
21352 Jeddah  
s.marine@samaco.com.sa  
+96 612 699 23 00

 **CANADA****QUEBEC**  
HQ DE ANTONIO YACHTS

C/ del Avenir 8  
08006 Barcelona  
sales@deantonioyachts

 **UNITED KINGDOM****POOLE**  
THE BOAT CLUB SALES LTD

Parkstone Bay Marina, Turks Lane,  
Poole, Dorset, BH14 8EW  
info@theboatclub.com  
+44 (0)1202 724912

**STUART**  
NAUTICAL VENTURES

3108 Southeast  
Monroe Street Stuart FL 34997  
sales@nauticalventures.com  
+1 (772) 283 9990

 **UNITED ARAB EMIRATES****JEDDAH**  
SAMACO MARINE

P.O. BOX #126417  
King Fahad road, Al Nahdah District  
21352 Jeddah  
s.marine@samaco.com.sa  
+96 612 699 23 00

 **MALTA****QORMI**  
STRAND MARINE & AUTO SYSTEMS LTD

Valdor Bldgs, Triq is-Sebh, Qormi  
QRM 9055, Malta  
+356 99 209 690

